



DALI AG

Digital Addressable Lighting Interface
Activity Group
ZVEI-Division Luminaires





Manual

DALI AG

**Digital Addressable Lighting Interface
Activity Group
ZVEI-Division Luminaires**

Publisher:
DALI AG (Digital Addressable Lighting Interface Activity Group)
of ZVEI, Division Luminares
Stresemannallee 19, D-60596 Frankfurt am Main, Germany
Tel.: +49(0)69 63 02-0 / Fax: +49(0)69 63 02-317

E-mail: licht@zvei.org
Internet: www.dali-ag.org

Copyright: 2001 by AG DALI, Frankfurt am Main
Richard Pflaum Verlag, Munich

All rights reserved. This includes all rights to publication, reproduction, as a whole or in parts, storage in a retrieval system or transmittance in any form or way by electronic or mechanical means, duplication as a photocopy or recording or otherwise.

Foreword

Specialists in the field of lighting, such as architects, light designer and installers, are the principal target group for this manual of basic information on "Digital Addressable Lighting Interface (DALI)".

DALI defines a standardized digital ballast interface. The manufacturer-independent DALI standard is specified in IEC standard 60929, which ensures interchangeability and interoperability of ballasts from various manufacturers.

The new standard is not merely a digital interface in addition to the current analogue 1-10 V control technology. Rather, it will gradually replace the latter because of its clear advantages.

DALI components make it possible to create a flexible, cost-effective and decentralized lighting system. DALI deals only with lighting system components. This limitation is not a disadvantage; it simplifies planning and installation.

DALI is simpler than building management systems and less expensive. Interfaces and converters can combine DALI components with any building management system; DALI can function as a stand-alone system or as a subsystem.

The aims of the DALI working group are to promulgate the new technology and to coordinate the activities of manufacturers. An information platform is available on the Internet: <http://www.dali-ag.org/>.

Helmuth K. Unger
President of the ZVEI Division Luminaires (since 2001)

Contents

1	Introduction	9
2	DALI – The digital addressable lighting interface	10
2.1	What is DALI?	10
2.2	DALI advantages	11
2.3	DALI-Partners: The Activity Group	13
3	DALI and Building Management	13
3.1	DALI as stand-alone system	13
3.2	DALI as stand-alone subsystem	15
3.3	DALI as pure subsystem within Building Management	16
4	General system description	17
4.1	Features	17
4.2	Selection of connecting wires	20
4.3	Voltage supply of the system	21
4.4	System size	22
4.5	Selection of units	23
4.6	Connectivity and operation	23
4.7	Electromagnetic compatibility	24
4.8	Address structure	24
5	Planning	25
5.1	Lighting system operating instructions	25
5.1.1	Forward planning	25
5.1.2	Specification	25
5.1.3	Advantages of DALI in planning	26
5.1.4	Organization	27
5.1.5	Planning	28
5.2	Component selection	28
5.2.1	Controls	28
5.2.2	Components for integration	30
5.2.3	Components for sub-circuits	30
5.2.4	Switch panels and sensors	30

6	Electrical installation	30
6.1	Routing and laying of cables	30
6.2	Checking and documentation	33
7	Commissioning	34
7.1	Assigning addresses	34
7.1.1	User identification	34
7.1.2	Using the individual address	35
7.1.3	Using the group address	35
7.1.4	Creating and storing lighting scene	35
7.2	Operating elements and sensors	35
7.3	Commissioning after system modifications	36
Appendix A	DALI-members and licensees (status: May 2001	37
Appendix B	Glossary: Terms and definitions	41
Appendix C	Standards	44
Appendix D	Literature	45
Appendix E	Application examples	46
Appendix E 1	Case study	47
Appendix E 2	Basic for simple applications	51
Appendix E 3	Example of a DALI application: combined work and training room	56
Index		59

1 Introduction

The demands on modern lighting technology are numerous. In former times there was but one objective, to provide light for visual tasks. Nowadays convenience, functionality and energy conservation are attractive features, which must be added as objectives. The traditional electric installation that is based on the simple wiring of light switches, dimmers and light consumers is inadequate of responding to these demands. Controls with analog interfaces, like the 1-10V control, neither provide the flexibility nor the capability of controlling individual lights in a system. This makes the extension of an existing system a rather difficult task. This is why installation bus systems have been developed since the 1980's allowing a digital communication between all participating components of a lighting system or even in the engineering of Building Systems. High functionality and flexibility of the technical unit is ensured in these systems, where commands are exchanged between control devices and electric consumers.

These installation bus systems, which are already established on the market, regularly entail a high expenditure for devices and systems. They also demand extensive system knowledge from both the designer and electrician that has to be acquired in special training sessions. Consequently the installation of such systems is labour-intensive and expensive.

This experience has laid the ground for the lighting industry to define a new standard for the digital communication between the individual components of a lighting system: the DALI-protocol (DALI = Digital Addressable Lighting Interface). The objective was to create a system with low cost components that is easy to handle. This system intentionally dispenses with the maximum possible functionality in the engineering of complex Building Systems in favour of simplified communication structures. An optimized set of commands is established, which are limited to the sensible func-

tions of a lighting control. The DALI concept stands for an intelligent, functional light management that is easy to apply and cost-efficient. It is possible to integrate DALI as a sub-system into superior Building System designs, if so desired, taking advantage of the available hardware and software interfaces and this at favourable prices.

2 DALI – The digital addressable lighting interface

The analog 1 – 10V control interface is the most common industry standard for the dimming of electronic ballasts today. DALI has been designed to become a new standard in the market. With its greater flexibility and simplicity of installation in a great variety of applications it will gradually replace the analog interface.

2.1 What is DALI?

DALI is an acronym and stands for “Digital Addressable Lighting Interface“. It is an international standard that guarantees the exchangeability of dimmable ballasts from different manufacturers. This gives planners, luminaire manufacturers, building owners, installers and end-users the security of supply from many sources.

The DALI-interface has been described in the fluorescent lamp ballast standard IEC 60929 under Annex E.

DALI is the ideal, simplified, digital way of communication tailored to the needs of present day lighting technology.

Communication and installation have been simplified as much as possible. All intelligent components communicate in a local system in a way that is both simple and free of interference. There are no special requirements for the wiring of data cables, and there is no need to install termination resistors on the cables to protect them against reflections.

DALI has been designed in a joint effort by all leading control equipment manufacturers with the idea of offering a standard to the lighting market that complies with all requirements.

All lighting component manufacturers are now in a position to solve complex lighting tasks in a simple and comfortable way.

With this standard you will now be able to offer your customer a full system solution (lamp – ballast – luminaire – control unit – lighting system).

2.2 DALI advantages

Users have the following options when installing DALI - ballasts in their lighting system:

- Simple wiring of control lines (no group formation, no polarity)
- Control of individual units (individual addressing) or groups (group addressing) is possible
- A simultaneous control of all units is possible at any time (built-in initial operation function) through broadcast addressing)
- No interference of data communication is to be expected due to the simple data structure
- Control device status messages (lamp fault, ...), (report options: all / by group / by unit)
- Automatic search of control devices
- Simple formation of groups through “flashing“ lamps
- Automatic and simultaneous dimming of all units when selecting a scene
- Logarithmic dimming behaviour – matching the eye’s sensitivity

- System with assigned intelligence (every unit contains amongst other things the following data: individual address, group assignment, lighting scene values, fading time,)
- Operational tolerances of lamps can be stored as default values (for example for the purpose of energy savings maximum values can be set)
- Fading: adjustment of dimming speed
- Identification of unit type
- Options for emergency lighting can be chosen (selection of specific ballasts, dimming level)
- No need to switch on/off the external relay for the mains voltage (this is done by internal electronic components)
- Lower system cost and more functions compared to 1–10V-systems

DALI has been defined for:

- a maximum of 64 single units (individual addresses)
- a maximum of 16 groups (group addresses)
- a maximum of 16 scenes (scene light values)

The intelligence of the system has not been centralized for the purpose of defining the DALI-interface for control devices. This means that many of the setpoints and lighting values are stored within the individual ballast:

- Individual addresses
- Group assignments
- Light scene values
- Fading times
- Emergency lighting level (System Failure Level)
- Power On Level

DALI closes the gap between conventional 1–10V-interfaces and complex lighting control systems. These are the features that make DALI stand out as the ideal platform for an intelligent and flexible lighting management in modern buildings.

2.3 DALI-Partners: The Activity Group

Under the roof of the German Central Association of the Industry for Electric and Electronic Products (registered committee: ZVEI) the Activity Group DALI was founded to establish this new standard in the market. Many leading manufacturers of control devices joined this group to develop and market their products according to the new requirements. For a low annual fee DALI AG is open for everybody who is interested.

Further information is available under www.dali-ag.org

3 DALI and Building Management

In the field of building management DALI positions itself as follows with respect to complexity and price:

As you can see in the graphics (*Fig. 3.1*) a lighting control system based on DALI is not suitable for Building Management due to its low complexity. Therefore, lighting control systems based on DALI can only be used as subsystems for lighting control within Building Management Systems (BMS). The integration of a DALI lighting control system into building management could be done as follows.

3.1 DALI as stand-alone system

This is the simplest option. In most cases, it will consist of a simplified control unit not using the full functionality of DALI. It is a real stand-alone lighting control system without

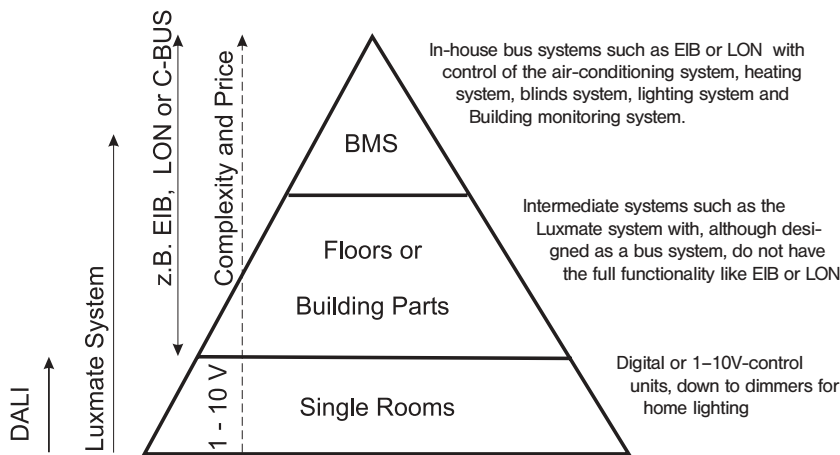

Figure 3.1: DALI and Building Management Systems

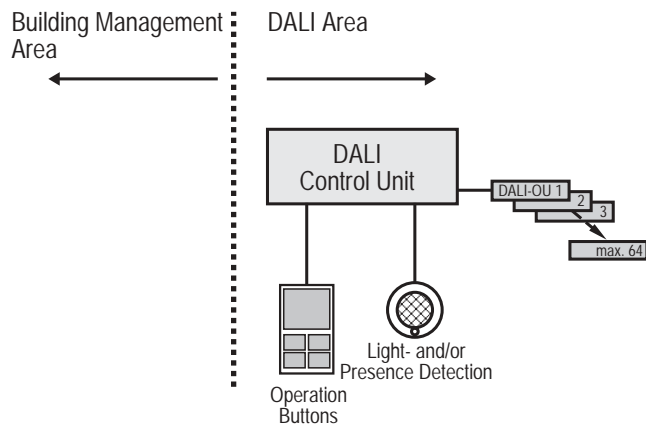

Figure 3.2: Stand-alone system

connection to the building management. All functions (even start-up, maintenance etc.) are carried out locally. Control elements and sensors are connected to the control unit as usual, in analog or digital form (Fig. 3.2).

3.2 DALI as stand-alone subsystem

This option is a stand-alone subsystem within the building management. However, compared to option one (see *Fig. 3.3*) it is connected to the building management system. Only the most important information (fault status, central switch functions etc.) will be exchanged with the building management. It can be in the simplest form a *yes* or *no* with regards to faults or failures. Sensors, control elements, programming unit and remote control can be integrated as usual (for example wireless). Initialisation can be carried out via building management provided that this option will be offered by the software tools.

This system is also operational without Building Management.

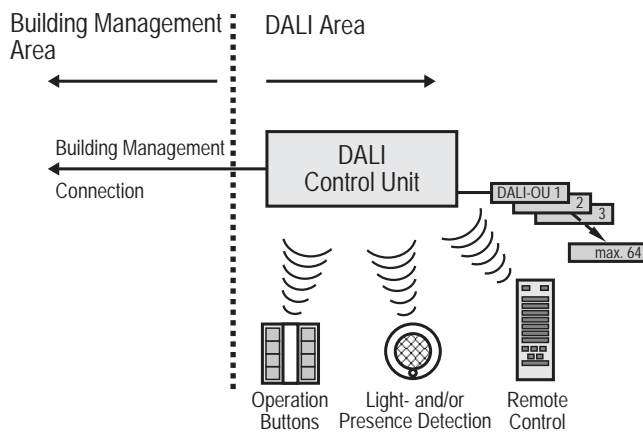

Figure 3.3: Stand-alone subsystem

3.3 DALI as pure subsystem within Building Management

A translator (gateway) is planned for this option. All components installed in a room or building part use the same technique of data transfer as the Building Management. The gateway translates from the Building Management to DALI and in reverse order to establish the communication between Building Management and DALI-units. A typical application for example is EIB that uses the appropriate control elements, switches, sensors etc.

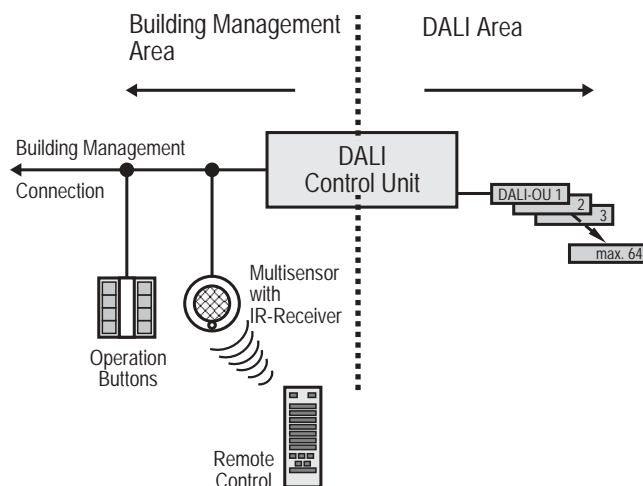

Figure 3.4: Pure subsystem

The lighting system has not been designed as stand-alone solution for this kind of application. In this case, initialisation of the lighting control system is part of the start-up process of the complete building management system.

4 General system description

4.1 Features

For the digital interface, specified in the draft of the IEC standard, there are several features, which operate under different principals than the features of the analog interface. Principally the digital interface represents an interface structure for lighting applications that can be enlarged. This new interface does not compete with BMS.

The analog interface and the signal level 1–10V allow for a connection of functional units (sensors and actuators) from different illumination electronics manufacturers. The 1–10V interface does not allow an individual addressing. Consequently all units, which are connected to a 1–10V interface, can be addressed in common only. Furthermore, the lamps' luminous flux relation has not been standardized with reference to the interface voltage (light differences). Another disadvantage is the fact that it is impossible to switch off the 1–10V units by means of the interface. To disconnect the units they need to be separated from the mains voltage.

Characteristics and features of the digital interface:

- **Definition in IEC 60929** – this allows the combination of units from different manufacturers. It must be emphasized as a special fact that all manufacturers, who are represented in the **AG DALI**, have made a joint effort to verify the compliance of their units with this standard to guarantee a **high functional security**.
- **Effective data transfer rate (1.200 bits/sek.)** – enables an interference-free operation of the system. The physical low-level has been defined with the interface voltage at 0 Volt (-4.5 Volt to + 4.5 Volt) on the receiver's side. The high-level condition is represented by the interface voltage of 16 Volt (9.5 Volt to 22.5 Volt) on the receiving side. A maximum voltage decrease of 2 V between sender and receiver is admissible on the leads of the interface.

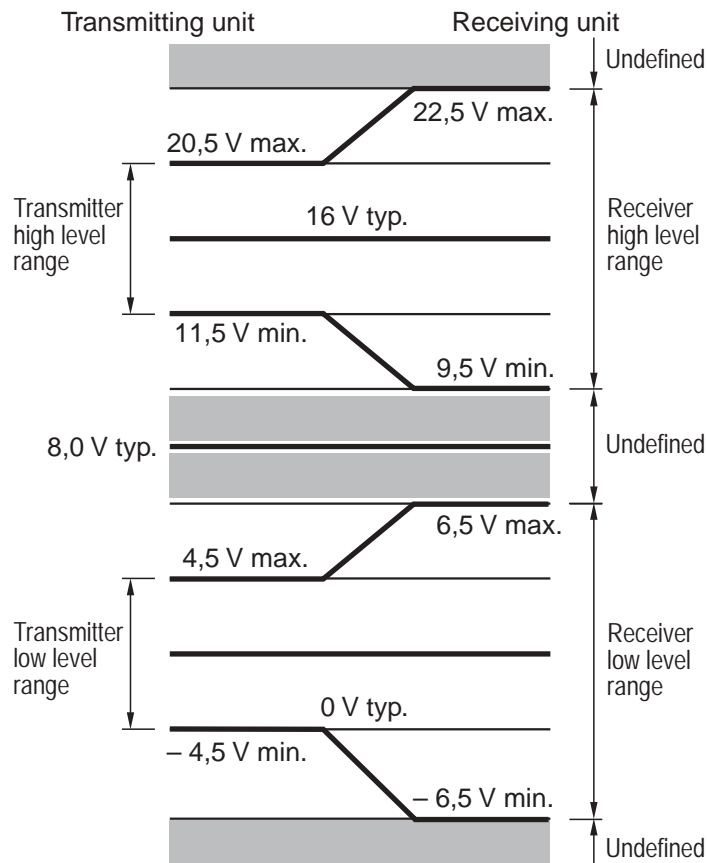

Figure 4.1: Voltage ratings

- **Safety distance of interference voltage** – a safe operation is guaranteed by the large-scale interference voltage distance between the sender and the receiver side.
- **Data coding** – the Manchester-Code has been used here; its structure allows the detection of transmission errors.
- **Maximum system current** – the central interface power

supply has been set to allow a maximum current input of 250 mA. Each participant connected to the interface may consume a maximum of 2 mA. This must be taken into consideration for the selection of the power supply interface.

- **Limited system size** – the maximum number of 64 units with an individual address can be distinguished within a system.
- **Revertive signals of information** – e.g. **ON/OFF, actual brightness** of the connected lamps, lamp state etc. are possible.
- **Two-wire control lead** – two base-isolations should be provided between two leads. A single-threaded isolation of a lead is therefore sufficient.

Control and supply leads can be wired together, make sure to install a minimum lead diameter according to the following table:

Lead length	Minimum lead diameter
up to 100 meters	0,5 mm ²
100 – 150 meters	0,75 mm ²
above 150 meters	1,5 mm ²

The maximum lead length between two connected systems must not exceed 300 meters.

- **Potentialfree control input** – the control input is separated galvanically from the mains voltage. Consequently all system participants may be operated with different outer conductors (phases).
- **No termination resistors required** – it is not necessary to terminate the interface leads with resistors.
- **Dimming range 0.1 % –100 %** – the lower limit depends on the manufacturer. The course of the dimming curve is standardized and adapted to the sensitivity of the eye (loga-

rithmic dimming curve). The impression of a similar brightness, when electronic ballasts of different manufacturers are used, is a result of the standardization. This requires however, that the lower limit of the dimming range is equal for all units (e.g. all units show a lower dimming range of 3 %) belonging to the same power class (lamp power).

- **Programmable dimming times** – special adjustments like adjusting light change speeds are possible.
- **Interruption of the data transfer** – fixed light adjustments are interpreted automatically (emergency operation).
- **Storage of lighting scenes** – a storage of up to 16 scenes is possible.
- **Connection to Building Management Systems by converters** – the very first design intent has been to apply the interface in rooms for an integration into BMS by means of converters.
- **Easy new configuration of the system** – Once installed and configured, a modification of the system function, the illumination scene or the illumination functions is only a question of configuration requiring no modification of the hardware. Example: Regrouping of luminaires into an open-plan office.
- **Easy integration of new components** – new components can be added everywhere within the system whenever an existing illumination system needs to be enlarged. Consideration should be made that the dimensioning of the system power supply will be sufficient.

4.2 Selection of connecting wires

No requirements for terminals and cables/wires, which have to be used for the digital interface, have been defined yet in the IEC-draft. Consequently cables and wires of commercial quality may be used for standard installation purposes. Neither has the structure of the connection for the different

components been defined. Thus star-shaped and mixed structures are possible besides linear or tree-shaped structures. As a rule ring-shaped connection of components should be avoided, however. The wiring of the corresponding leads is subject to the same installation conditions as are applicable for power installations. This is also valid for the installation of illumination systems in special rooms (harmonized installation regulations).

The selection of wires must be adapted to both the length of the connection and the existing terminals. To enable a correct recognition of the information level at the actuators, a maximum voltage drop of up to 2 Volt is allowed across the connecting wires from the interface supply to each system participant. The supply interface may be installed anywhere in the system or in any device. Due to the low transmission-rate there is no need to use special cables or wires, as for example, twisted or shielded cables. Installation material of commercial quality can be used for the connection between wires and units. As a rule, a distance of 300 m should not be exceeded between two communicating units. As the digital interface is separated galvanically from the mains supply of an actuator, actuators, which are connected to different phases of the mains voltage (L1, L2 or L3), can nevertheless be connected with each other.

The isolation of the digital interface corresponds to the requirements of the base isolation. Tests are executed under the IEC 60 928 standard. Thus, **SELV** (Safety Extra Low Voltage) is not granted. The digital interface connecting leads can be wired jointly with the mains supply leads (e.g. 230 V), always provided that the isolation strength (2 x base isolation) will be observed.

4.3 Voltage supply of the system

In general, the interface voltage is 16 volt ranging from 22.4 volt to 9.5 volt).

Different units are capable of supplying the interface:

- a separate, central interface supply unit
- a control unit with integrated interface supply
- a control device with a supplementary internal interface supply.

The maximum system current has been limited to 250 mA. The current limitation avoids an overload on the interface's switching function that has been incorporated into each system participant.

The smallest possible system, an illumination unit with a control unit, requires a current of 2 mA max for the electronic ballast on top of the current required for the control unit. There is no limitation to the maximum control unit current. With the impedances of different interface components being identical in the field the correct power supply for the system must be selected to correlate to the accumulated currents from the individual components. Good practice is to allow sufficient margins for the supply current. This will guarantee reliable system functionality under different conditions also allowing the flexibility for possible system expansions at a later date. When a system is operated with several sources of supply, the polarity of the system supply must be taken into consideration when connecting the system leads. The maximum total current that is supplied by all sources of the system supply must not exceed 250 mA.

4.4 System size

Up to 64 individual addresses including control devices and control units may be connected to one interface-line. The total current of one interface-line is limited to 250 mA. Whenever a system is planned, which is to contain control devices as well as control units, it must be ensured that neither limit value will be exceeded. In a case, where the system will exceed these limits problems must be expected, which are due to the reduced signal integrity. Some components may fail to communicate or respond to commands and the system operation will become unstable. For this reason the

system planner must take the power consumption of each component (control device and control unit) into consideration in addition to the addresses and, furthermore, plan a certain reserve in order to provide for the possibility of an extension at a later date.

4.5 Selection of units

The draft standard allows for the compatibility of the ballasts. For all other variants, such as sensors and controllers, the planner has the responsibility to ensure in the product specification that the compatibility can be guaranteed.

The draft standard defines the following types of units:

Typ	0	Standard units
Typ	1	Units for emergency lighting
Typ	2	Units for discharge lamps
Typ	3	Units for low voltage halogen lamps
Typ	4	Dimmable units for incandescent lamps
Typ	5	1-10V interface converter
Types	6-255	Reserved for future units.

This way all units are compatible.

4.6 Connectivity and operation

Principally, there are two possibilities to connect actuators, control units and ballasts with one another:

Operation with one control unit only actuating as the master of an interface-line. In this operating mode control panels and sensors have been connected to a control unit that controls the connected ballasts as well. The ballasts provide information on request by the control unit only. The overall handling has been assigned to this single control unit (Single Master).

Operation with several control units working as masters of

an interface-line. In this operating mode several control units (e.g. sensors or panels) can communicate directly with the ballasts. The controllers have to follow some defined common "traffic rules" to avoid data collision and to maintain the correct system functions. In this operating mode installations will become easier with the extent of required wiring being reduced (Multi-Master).

4.7 Electromagnetic compatibility

With the slope steepness of the transmission signals as well as the height of the voltage levels being limited there are no high interference levels originating from the signal lead. All equipment used in an installation must meet the stipulations defined in the actual issue of CISPR 15, IEC 61 547, IEC 61 000-3-2 and IEC 61 000-3-3.

4.8 Address structure

An address stands for the definite designation of a unit within a DALI-system. An address can be compared to a house number assigned to an individual house in the same street. The street may be compared with the interface-line. The house number characterizes each house in the street making it possible to differentiate between all houses of the same street.

Within a DALI-system each ballast has its own address. This way it can be contacted individually, although it is connected to a DALI system-line like all the other units. The address assignment, for example, must be effected when the system is put into operation.

All units of a system can be contacted at the same time by way of a broadcast.

A differentiation is made between individual addresses and group addresses.

64 individual addresses exist in the DALI-system. Thus, one

or several control units can contact individually, i.e. a maximum of 64 ballasts. Each ballast may also be part of a maximum of 16 groups.

Generally the assignment of the addresses and with that the assignment of the group addresses is effected by a software. Thus the system configuration can be modified without any modification of the installation itself.

5 Planning

5.1 Lighting system operating instructions

5.1.1 Forward planning

The planning of a lighting project with DALI interfaces is basically a similar exercise to planning a project with analog interfaces. A well-thought-out and tidy preparation facilitates the installation minimizing the cost that can result, when planning mistakes become evident no sooner than after completion. This chapter deals with the merits of DALI components in the planning process.

5.1.2 Specification

The specification will establish the lighting requirements. The technical lighting details, like the type of fittings including lamps and controls such as sensors, switch panels and interface modules, will be indicated in various documents.

The component family types have been described in chapter 5.2 to provide assistance in the drafting process. It should be noted that some controls will require special switch panels and sensors. The general recommendation is to use standard components only. Please refer to chapter 5.2.1

The functionality of the system is defined mainly by the con-

trols. This should be considered when selecting the individual elements or responding to any special requirements. The location of some elements may have been defined in the specification already. Chapter 4 deals with cables, power supply, EMV etc.

5.1.3 Advantages of DALI in planning

A Dali-system enables the control of single lights or groups of fittings without the need for parallel wiring. Furthermore all planning for the switching of loads in the mains supply can be omitted, as fittings can be switched *on* and *off* by DALI. It is not really necessary during planning to consider the allocation of switches, control panels and sensors etc. to the fittings, as this can be done retrospectively without any re-wiring. The connection configuration can also be considered later, as DALI permits a combination of star and series connections. See *Figures 5.1* and *5.2*

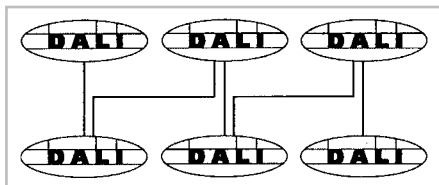

Figure 5.1: Serial connections

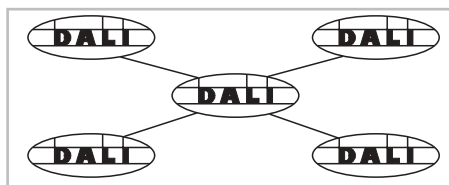

Figure 5.2: Star connections

Figure 5.3 illustrates an example of a combined installation. The two areas are joined to each other by a series connection. Area 1 has a star configuration and area 2 has a combination of star and series connections.

Series wiring can mean easier cable laying; compared to other methods a star configuration in many cases can offer an advantage with respect to cable length.

As demonstrated in the examples, there is no termination resistor at the DALI component cable-ends. A possible cause of interference in the data transfer has been eliminated this way.

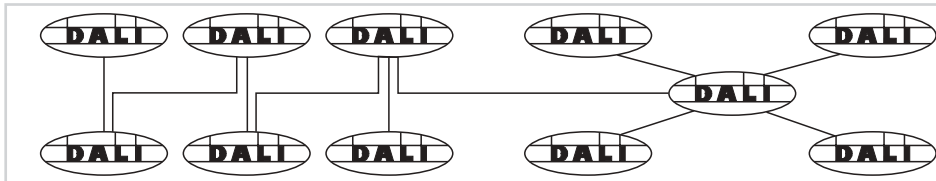

Figure 5.3: Combined installation

The intended allocation of the cables should be clearly indicated on the plans and in the installation in order to facilitate repairs and modifications.

5.1.4 Organization

The organization of the light fittings and the associated controls should be carried out during the outline planning phase. This should be indicated clearly on the layout drawing. The installers will enter the relevant addresses during the commissioning:

- Light designation
- Floor
- Room
- Position on the plan
- Group reference
- Control address
- Belongs to group



The configuration of the lighting is carried out during the commissioning and can be changed later, if so desired.

Ref. No.:	Floor:	Room:	Position in plan:	Belongs to group:	DALI Control adress:
L231/01	2	31	01	1	55
L231/02	2	31	02	1	32
L231/03	2	31	03	1; 2	34
L231/04	2	31	04	2	05
L322/01	3	22	01		
...

Example

5.1.5 Planning

A DALI-system makes no special or extra demands on the person doing the planning, but increases the flexibility during the design, installation and application stages. It will accommodate last minute changes requested by the end user.

The following seven points should be considered during the design stage:

- Two wires have been included for the DALI interface?
- The maximum cable length has been maintained?
- All relevant wiring regulations have been observed?
- The specified number of DALI components has not been exceeded?
- The fields for the addresses of the DALI components have been indicated clearly in the documents?
- All light fittings, sensors, switch panels and control units have been considered?
- Are there any specific requirements for the control units?

5.2 Component selection

A DALI-interface control system can comprise parts from the table.

Due to the fact that DALI has been defined just recently, a rapid development of new components should be expected.

5.2.1 Controls

The control units supply the logic co-ordination between sensors, switch panels and DALI operating equipment. This can be done through a stand-alone unit or by an interface which receives commands from a master system. Intelligent sensors or switch panels with integrated controls are also possible.

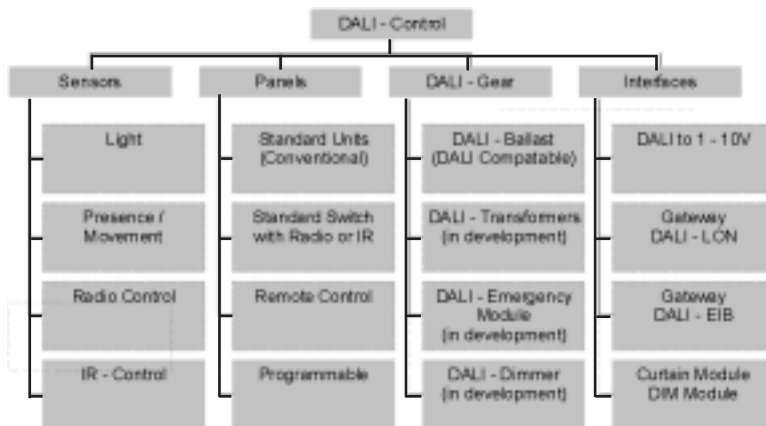

Particular attention should be given to the connection between sensors/switches and the control units.

There are two variations:

Method 1

Sensors and switches are joined directly to the control units by separate connections. This method facilitates the use of components, which are standard in this sector of industry.

Method 2

Sensors and switches are connected to the control units by the DALI cables. In this case no additional wires need to be laid to link the sensors/switches with the control units.

Both solutions have their advantages, which are dependent on the application; the application will be decisive for selecting method 1 or method 2.

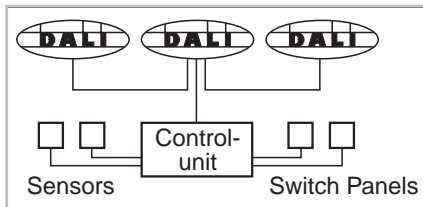

Figure 5.4: Method 1

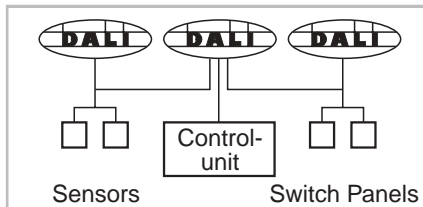

Figure 5.5: Method 2

For more detailed information about the sensor and switches, which can be operated by the control units, please refer to the manufacturer's product data sheet.

5.2.2 Components for integration

Control devices in standard configuration are available for the installation in light fittings. Refer to the manufacturer's product data sheet.

5.2.3 Components for sub-circuits

In sub-circuits (with fusing) both the DALI units and mains units can be accommodated. The DALI units have to comply with the same wiring guidelines as mains voltage equipment. The control units should be installed in accordance with the manufacturer's instructions.

5.2.4 Switch panels and sensors

Switches and sensors are available in a great variety meeting all requirements. These range from conventional standard units through multi-function panels to daylight sensors with integrated IR-receiver. Considering this wide range of options the relevant manufacturer's data sheet should always be consulted.

6 Electrical installation

6.1 Routing and laying of cables

The electrical installation of lighting control systems with a DALI interface must be carried out by an authorised electrical engineer in accordance with the pertaining power system regulations.

The prevailing technical conditions, such as observing the maximum number of users for each pair of DALI bus wires or the cable length, must also be complied with (see Chapter 4). Up to now – as for the 1–10V technology – function was determined by the wiring of the components as well as sensors and control devices (*Fig. 6.1*). In the case of installations with DALI, however, function is determined by the specific DALI control device that is put into service and the technical characteristic thereof.

Figure 6.1:
Wiring

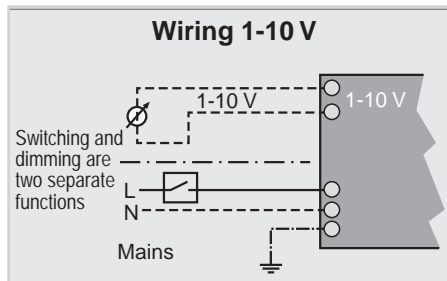
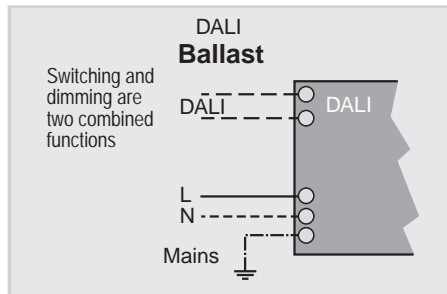

Figure 6.2:
Ballast



The DALI control bus may be installed at the same time as the power system (*Fig. 6.3*). It consists of a pair of cables, the same as for the 1–10V interface.

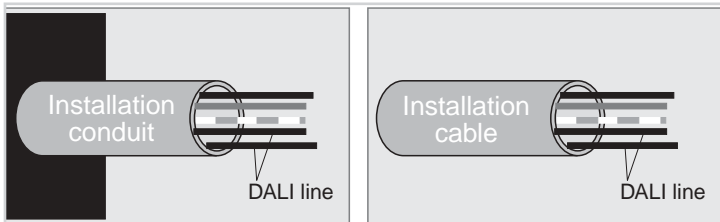

Figure 6.3: Control bus lines

Compared with the 1–10V interface, the DALI control line requires no other electrical installation tool, auxiliary device or measuring and testing equipment. There is no requirement for special data cables. However, it is necessary to ensure that a clear method of identification is applied. Both the power supply and the DALI control line can be run through a 5-wire cable. Do observe the national regulations on installation at all times. Principally there is no need to follow specific guidelines when connecting the individual DALI components to the DALI control line. However, for the sake of clarity, it is recommended that the wiring system will always be the same throughout one building. Power and the DALI lines as well as the associated installation equipment may be installed in parallel in terminal blocks. The maximum voltage drop on the DALI line may not exceed 2V. The resulting maximum line length is 300 m, the largest permissible distance between two DALI components (*Fig. 6.4*).

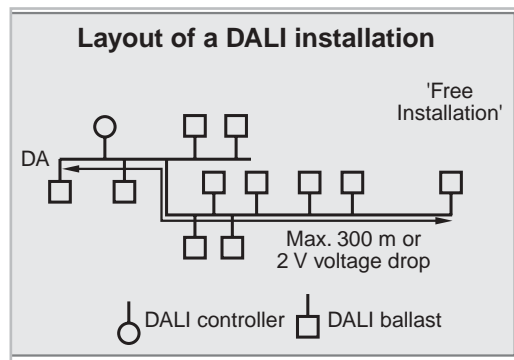

Figure 6.4:
Installation

6.2 Checking and documentation

The following points should be documented during the final check of a DALI installation:

- Has the installation been executed in accordance with the regulations for mains voltage installation and checked?
- Line lengths between DALI users:
The maximum voltage drop on the DALI line may not exceed 2 V with a resulting maximum line length of 300 m between the first and the last DALI components. Verify that the planned line length and the actual line length are the same.
- Maximum number of DALI users for each line:
The maximum number of users depends on the DALI control device used. The DALI standard specifies a voltage and Current of 22.5 V and 250 mA respectively. The electronic DALI consumers represent a maximum consumption of 2 mA. Verify that the maximum permissible number of operating devices has not been exceeded.
- Function of the DALI operating devices:
The DALI operating devices switch to max. luminous flux, when the mains voltage is applied. Check that all operating devices switch to max. luminous flux when being connected to the mains.
- DALI wiring check:
Switching on/off via the control device. Check that the light can be switched on and off.
- Testing the functions of the DALI control device:
The procedure depends on the manufacturer and must be carried out in accordance with the manufacturer's specifications.
- Insulation test:
The insulation test must be carried out in accordance with the regulations.

7 Commissioning

The commissioning of DALI systems depends primarily on the control device used. Therefore do observe the instructions for the commissioning provided by the relevant control device manufacturer.

Consequently, only the essential features for commissioning, which are governed by the definition of the DALI interface, have been outlined in this chapter. The control device software and the facilities, which are provided by the operating system, will determine most of the technical characteristics.

7.1 Assigning addresses

7.1.1 User identification

It will be possible to identify the connected DALI users, as soon as the control device and power supply have been connected. The search for DALI users can be carried out in two different ways:

1. The control device registers all operating devices connected to the DALI system using its own basic ID stored by the manufacturer during production (address length: 24 bit). If two long addresses are identical, a random function triggered by the control device can be performed within the ballast. A new long address will be created in the result.
2. The DALI user will be identified by disconnecting the lamp connection at the operating device. The operating device must be connected to the mains at this time.

In each case an individual and/or a group address will be assigned to each known DALI user directly upon their identification according to the requirements.

Another possibility is an assignment of addresses prior to the installation, which allows for a harmonization of all DALI operating devices.

7.1.2 Using the individual address

The assignment of an individual address will enable you to check the individual operating device and/or carry out an error detection for each individual operating device.

7.1.3 Using the group address

It is possible to assign group addresses to any combination of operating devices forming addressable groups e.g. for combined control purposes, as appropriate. Group addresses can be assigned by the user via control device during the identification phase.

7.1.4 Creating and storing lighting scenes

Once the individual operating device has been identified or groups have been assigned, lighting scenes can be created by setting the individual lighting levels for the individual devices or groups. The individual scenes are stored by way of a command from the control device in the DALI operating device. A maximum of 16 scenes or light levels can be stored for each user.

7.2 Operating elements and sensors

The specified DALI structure enables the use of sensors, push buttons, control consoles, touch panels or even PC operator interfaces. The information can be transmitted via a wire, infrared or radio link. The linking to the DALI system must be carried out in accordance with the specifications provided by the manufacturer of the control device.

7.3 Commissioning after system modifications

Whenever new devices are added or existing devices replaced, the new users of the control device need to be identified (see 7.1.1). This can be done by changing all addresses or just the selected addresses in accordance with the particular control system.

For further details please refer to the operating instructions for the relevant control device.

Appendix A

AG DALI – Members and Licensees (Status: September 2001)

BAG TURGI ELECTRONICS AG

P. O. Box 227
CH-5300 Turgi
Tel.: 0041 56 20 10 49 3
Fax: 0041 56 20 10 46 9
E-Mail: meyer@bagturgi.com

Delmatic Ltd.

117, Cleveland Street
GB-London W1T 6PX
Tel.: 0044-20 7927 6500
Fax: 0044-20 7927 6525
E-Mail: bruce.brown@delmatic.com

DIAL

Gustav-Adolf-Str. 4
D-58507 Lüdenscheid
Tel.: (0 23 51) 10 64-3 80
Fax: (0 23 51) 10 64-3 81
E-Mail: DIALog@DIAL.de

Eckerle Industrie-Elektronik GmbH

Postfach 13 68
D-76310 Malsch
Tel.: (0 72 46) 9 20 40
Fax: (0 72 46) 92 04-43/44
E-Mail: ee.malsch.Boehmer@t-online.de

ERC

Elletro Radio Construzioni S.P.A.
Via dei Sassi 2
I-23801 Calolziocorte (LC)
Tel.: 0039-341 63 73 11
Fax: 0039-341 63 73 00
E-Mail: r.borsani@erc.it

ERCO Leuchten GmbH

Postfach 24 60
D-58505 Lüdenscheid
Tel.: (0 23 51) 5 51-3 60 / Fax: (0 23 51) 5 51- 5 31
E-Mail: n.hoebing@erco.com

GITRONICA SRL

Via A. Avogadro 22/B
I-62010 Montelupone (MC)
Tel.: 0039 (0)733225211 / Fax: 0039 (0)733224036
E-Mail: maurizio.senigagliesi@gitronica.com

HADLER GmbH

Fritzlärer Str. 19
D-34587 Felsberg
Tel.: (0 56 62) 93 99-0 / Fax: (0 56 62) 93 99-29
E-Mail: michael.lamkowski@hadler-gmbh.de

HELVAR OY AB

Purotie 3
FIN-00380 Helsinki
Tel.: 00358 9 56 54-1 / Fax: 00358 9 5654 9600
E-Mail: mans.paul@helvar.com

HÜCO electronic GmbH

Postfach 12 28
D-32326 Espelkamp
Tel.: (0 57 72) 5 67-0 / Fax: (0 57 72) 5 67-9 40
E-Mail: r.boeker@hueco.de

INSTA Elektro GmbH & Co. KG

Postfach 18 30
D-58468 Lüdenscheid
Tel.: (0 23 51) 93 60 / Fax: (0 23 51) 9 36-1 99
E-Mail: h.schliffke@insta-elektro.de

International Rectifier

101 Sepulveda Blvd
El Segundo CA 90245
USA
Tel.: 001 310 726 88 70 / Fax: 001 310 726 88 46
E-Mail: Tribari1@irf.com

LIGHTOLIER CFI

3015, Lous Amos
Lachine (Quebec) H8T1C4
Canada
Tel.: 001 514 636-0670
Fax: 001 514 636-4647
E-Mail: hyaphe@canlyte.com

LUTRON Electronics Co., Inc.

7200 Suter Road
GB-Coppersburg, PA 18036-1299
Tel.: 0044 61 02 82 38 00
Fax: 0044 61 02 82 62 88
E-Mail: phakkarainen@lutron.com

Luxmate Controls GmbH

Schmelzhütterstr. 26
A-6850 Dornbirn
Tel.: 0043 5572/5 99-0
Fax: 0043 5572/5 99-6 99
E-Mail: luxmate@luxmate.co.at

May & Christe GmbH

Hauptstr. 204
D-63814 Mainaschaff
Tel.: (0 60 21) 7 06-0
Fax: (0 60 21) 7 06-1 72
E-Mail: abel@maychriste.de

OSRAM GmbH

D-81536 München
Tel.: (0 89) 62 13-22 85
Fax: (0 89) 62 13-34 56
E-Mail: h.birkhofer@osram.de

PHILIPS LIGHTING B.V.

Kantsingel 24
NL-5349 AJ Oss
P.O. Box 1
NL-5340 AA-Oss
Tel.: 0031-412-682465
Fax: 0031-412-635990
E-Mail: richard.van.heijningen@philips.com

Sander Elektronik AG

Postfach 93
CH-Kleindöttingen
Tel.: 00 41 56 245 28 35
Fax: 00 41 56 245 38 58
E-Mail: sanderelek@pop.agri.ch

TCI TELECOMUNICAZIONI ITALIA SRL

Via Varese 11
I-21047 SARONNO
Tel.: 00 39 02 96 41 61
Fax: 00 39 02 96 41 62 57
E-MAIL: tci@tci.it

TRIDONIC Bauelemente GmbH

Industriestr. 25
D-89269 Vöhringen
Tel.: (0 73 06) 96 62-13
Fax: (0 73 06) 96 62 15
E-Mail: domokoschh@tridonic.de

TROLL

J. Feliu de la Penya S.L.
Pso. de la Ribera, 190
E-08420 Canovelles, Barcelona
Tel.: 0034-93 846 6909
Fax: 0034-93 846 5709
E-Mail: carles@troll.es

Vossloh-Schwabe GmbH

Hohe Steinert 8
D-58509 Lüdenscheid
Tel.: (0 23 51) 1 01-1 80
Fax: (0 23 51) 1 01-1 36
E-Mail: norbert.wittig@VSL.vossloh.com

WILA- Leuchten GmbH

Voedeweg 9-11
D-58638 Iserlohn
Tel.: (0 23 71) 8 23-0
Fax: (0 23 71) 8 23-2 45
E-Mail: Ulrich.Kuhbier@wila.com

Appendix B Glossary

Terms and definitions

Algorithm	mathematical method to be used for calculations
Analog interface	control input and/or output for line or signals having i.e. voltage or current values
Backbone BMS	higher level bus system for BMS Building Management System
Broadcast addressing	messages are sent to every member of the system
Configuration offline	initial settings are given to units before they are connected to the system
Configuration online	initial settings are given to units which are connected to the system
Control line	cable or wire for control signals
Data communication	transfer of digital data
Data transfer rate	the speed of transferred data, measured mostly in bits per second
Digital interface control	input or/and output for digital signals
Electronic ballast	electronic control device for discharge lamps
Emergency light fitting	luminars that have to work also with mains voltage switched off
Emergency operation	specified working status for units in case of emergency situations
Fade time	time for the light level to change from initial level to end level
Feedback	returned data to control units, used for corrective operations

Gateway	unit, which selectively passes and transforms data between different systems
Group address	common address for a specified group
<hr/>	
HVAC	heat, ventilation and air conditioning
<hr/>	
IEC 60929	international standard for electronic ballast performance requirements
Individual address	unique address for each unit in the system
Interactive control	control with feedback and hand-shaking
Interference	disturbing effects caused to or by external units
IR receiver	receiver based on modulated infrared light
<hr/>	
Line length	the total length of the wiring/cabling
Local control	control of a small closed system, e.g. in the same room
<hr/>	
Logarithmic dimming curve	each up or down dimming step causes a constant relative change as compared to the previous level
<hr/>	
Manual control override	a manual control taking over from the automatic system control
Multi master	several active masters to control functions of a system
Multi-function daylight sensor	light sensor combined with other functions such as presence detection and IR control
<hr/>	
Operation modes	different working functions for a system
<hr/>	
Parameter	settable value to characterise units
Polarity	description of the direction for DC fields or currents (negative or positive, N or S)

Query	specified question to members in a system
Receiver	a unit able to listen to signals
Revertive signal	signal in a feedback message
Ring-shaped structure	units connected in a loop
SELV	safety extra low voltage
Sender	transmitter, a unit sending signals
Signal integrity	failure free signal
Single master	only one controller in a system
Status	measures or parameters describing the present situation of a unit
Sub-circuit	part of a larger circuit
Sub-system	part of a larger system
Synchronous dimming	simultaneous changing of light level for several units
System configuration	setting of desired parameter such as addresses and scene levels for units or a system
Terminator	unit used for cables to limit reflections
Traffic rules	directives to avoid collisions when transferring data
Transmission rate	data throughput, measured mostly in baud or bits per second
Transmitter	unit sending data or signals
Tree-shaped structure	units connected in system via own stubs to the main line
Wiring topology	shape of cable connections

Appendix C Standards

- DIN VDE 1000-10 Anforderungen an die im Bereich der Elektrotechnik tätigen Personen
- DIN VDE 0100 Errichten von Starkstromanlagen mit Nennspannungen bis 1000 V (Elektrische Anlagen von Gebäuden)
- DIN EN 50110-1/DIN VDE 0105 Betrieb von elektrischen Anlagen
- DIN VDE 0106 Schutz gegen elektrischen Schlag
- DIN VDE 0110 Isolationskoordination für elektrische Betriebsmittel in Niederspannungsanlagen
- DIN VDE 0470-1/EN 60529 Schutzarten durch Gehäuse (IP-Code)
- DIN EN 50102 Schutzarten durch Gehäuse für elektrische Betriebsmittel gegen äußere mechanische Beanspruchungen (IK-Code)
- DIN VDE 0606 Verbindungsmaterial bis 690 V – Teil 1: Installationsdosen zur Aufnahme von Geräten und/oder Verbindungen
- DIN VDE 0800 Fernmeldetechnik
- DIN VDE 0815 Installationskabel und -leitungen für Fernmelde- und Informationsverarbeitungsanlagen
- DIN EN 50090 Elektrische Systemtechnik für Heim und Gebäude (ESHG)
- DIN EN 50081/VDE 0839-81 Elektromagnetische Verträglichkeit (EMV); Fachgrundnorm Störaussendungen
- DIN EN 50082/VDE 0839-82 Elektromagnetische Verträglichkeit (EMV); Fachgrundnorm Störfestigkeit
- DIN 18015 Elektrische Anlagen in Wohngebäuden
- DIN 40719 Schaltungsunterlagen
- DIN EN 60617 Grafische Symbole für Schaltpläne
- DIN 43871 Installationskleinverteiler für Einbaugeräte bis 63 A
- DIN 43880 Installationseinbaugeräte; Hüllmaße und zugehörige Einbaumaße
- DIN 49073-1 Gerätedosen aus Metall oder Isolierstoff zur Aufnahme von Installationsgeräten bis 16 A, 250 V
- DIN EN 50022 Industrielle Niederspannungs-Schaltgeräte; Tragschienen, Hutschienen, 35 mm breit, zur Schnappbefestigung von Geräten

- DIN EN 61082 Dokumente der Elektrotechnik
- VBG 4 Unfallverhütungsvorschrift – Elektrische Anlagen und Betriebsmittel
- DIN EN 55015 Grenzwerte und Messverfahren für Funkstörungen von elektrischen Beleuchtungseinrichtungen und ähnlichen Elektrogeräten
- DIN EN 60928 Geräte für Lampen – Wechselstromversorgte elektronische Vorschaltgeräte für röhrenförmige Leuchtstofflampen – Allgemeine und Sicherheitsanforderungen
- DIN EN 60929/A2 Wechselstromversorgte elektronische Vorschaltgeräte für röhrenförmige Leuchtstofflampen – Anforderungen an die Arbeitsweise
- DIN EN 61000-3-2 Elektromagnetische Verträglichkeit (EMV) – Teil 3: Grenzwerte; Hauptabschnitt 2: Grenzwerte für Oberschwingungsströme
- DIN EN 61000-3-3 Elektromagnetische Verträglichkeit (EMV) – Teil 3: Grenzwerte; Hauptabschnitt 3: Grenzwerte für Spannungsschwankungen und Flicker in Niederspannungsnetzen für Geräte mit einem Eingangsstrom ≤ 16 A
- DIN EN 61547 Einrichtungen für allgemeine Beleuchtungszwecke – EMV-Störfestigkeitsanforderungen

Appendix D Literature

- Seip, G. (Hrsg): EIB Handbuch Gebäudesystemtechnik. (ISBN 3-89578-076-6). Weinheim: Publicis MCD/VCH 1999.
- Hidde, A.; Knoll, U.; Siebel, B.; Winter, A.: Funk-Gebäudesystemtechnik. Schalten, Steuern, Regeln und Überwachen per Funk. (ISBN 3-478-93207-6). Landsberg: moderne industrie 1999.
- Rosch, R.; Dostert, Kl.; Lehmann, Kl.; Zapp, R.: Gebäudesystemtechnik. Datenübertragung auf dem 230-V-Netz. (ISBN 3-478-93185-1). Landsberg: moderne industrie 1998.
- Hoppmann, W.: Die bestimmungsgerechte Elektroinstallationspraxis. (ISBN 3-7905-0768-7). München: Pflaum 1998.
- Scherg, R.: EIB planen und installieren. (ISBN 3-8023-1746-7). Würzburg: Vogel, 1998.

Rose, M.: Gebäudesystemtechnik. (ISBN 3-7785-2643-X).
Heidelberg: Hüthig 1999.
Weis, B.: Grundlagen der Beleuchtungstechnik. 2. Auflage.
München: Pflaum Verlag 2001.

Appendix E

Application examples

Appendix E1

Case study

Site survey

A modern office building with 5 floors. Each floor consists of a connecting walkway and service access with 5 separate areas extending from the walkway as adjacent blocks. Each block has the same layout of an open plan working area and an associated meeting room.

Three sides of each block extension have glass walls.

The customer's needs

For aesthetic reasons the lights have to be on at all times. At night the Building Management System (BMS) is to set the lighting to low level and subsequently restore to working levels the following morning. To allow an interactive and intelligent control of lighting and services the BMS must register the action and status of each area at all times.

Each working area is to have manual control override by means of simple push button panel. The BMS must be aware of the occupancy in each meeting room providing for an independent lighting by way of a remote control. No wall panels. The customer had already decided on a LONWORKS® backbone for the BMS.

Implementation

A DALI system was specified by area to offer the service feedback from each individual ballast. A DALI-LONWORKS® gateway provided a simple means of connection to the LONWORKS® BMS for direct control by the BMS. A push panel was chosen to be fitted next to the entry door for a simple scene selection. The 7 button panel variant was chosen to offer a raise and lower function of the selected scene to enhance user freedom. All panel actions are transferred to the BMS via the gateway to maintain an awareness of all manual intervention.

A Multisensor was chosen for the meeting room. This offers occupancy detection, light measurement and an IR remote link. A second gateway was used to offer fully autonomous control for the meeting room. There are no restrictions to the connection of the second unit, going directly between the DALI and LONWORKS®, in effect in parallel with the first gateway.

Occupancy information is forwarded to the BMS to facilitate HVAC control of ventilation on/off when the room is occupied/unoccupied and scheduling of light level changes only, when the room is unoccupied.

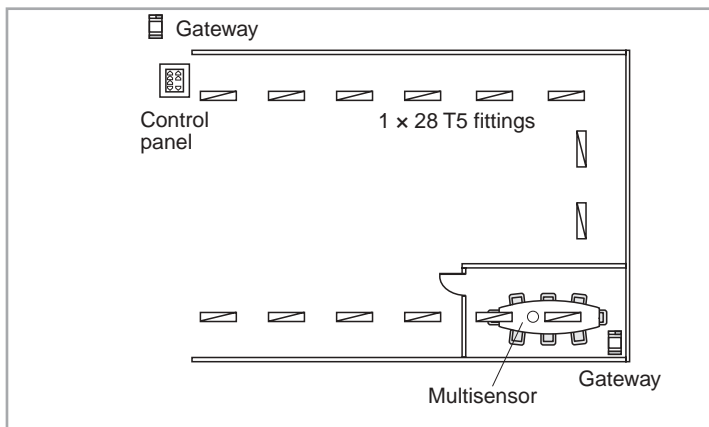

Figure E 1.1: Floor plan showing an open plan office and associated meeting room. All areas similar

The choice of DALI ballasts further simplifies the installation, as the ballasts provide the supply power to the gateways with control panel and multisensor removing the need for a separate DALI supply module.

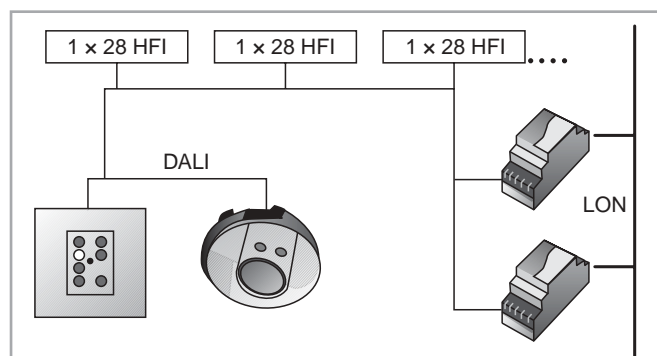

Figure E 1.2: Gateway

Gateway specification overview

LonMark® 3.2 interoperable.

A gateway between DALI and LONWORKS® systems, allowing an exchange of commands and information between a DALI area and the Building Management System for monitoring and master control purposes.

DIN-rail mounting case, 36mm wide (4x9 mm modules)
90mm height x 58mm depth.

Powered from the networks themselves, no additional supply requirement; from DALI 2 mA, and LONWORKS® 1 LPUL

Message types from DALI to LONWORKS®:

SNVT_switch	(On/Off/Up/Down)
SNVT_scene	(Scene number)
SNVT_occupancy	(Occupied/Unoccupied)
SNVT_lux	(Light level)
UNVT_status	(DALI device status)

From LONWORKS® to **DALI**:

SNVT_switch	(On/Off/Up/Down)
-------------	------------------

SNVT_scene (Scene number)
UNVT_status_request (DALI device status request)

The three levels of DALI addressing are provided for LON-
WORKS® commands.

Broadcast: To all devices in the DALI system.
Group To all devices in the defined group.
Device To the specifically addressed device.

Operation

DALI defaults offer functionality to a DALI system, even when the power is applied for the first time. The ability to have basic lighting control is a powerful feature. It enables the use of the lighting and facilitates a system check prior to commissioning.

The configuration of the system, the definition of how the various system components have to interact, was an easy task with the Digidim Toolbox running on a notebook computer. Note that here, with the small number of independent groups, only 2 per area were required. A configuration would have been equally as simple using the Digidim IR remote. The security and the simplicity of configuring multiple areas of the same layout are outstanding benefits of the Toolbox. The Toolbox allows an offline configuration with a parameter downloaded at the time of being connected to the physical system. Alternatively the configuration parameters can be read from a system and memorized for a project. Minor changes can easily be realized to suit an individual area, if needed, and then downloaded in a few moments.

After completion of the first area configuration, the same file was downloaded again for each one of the other areas without any further input effort. The notebook PC is no longer required, once the configuration has been completed. The electronic source files can easily be processed, reviewed and kept off site as a security file.

Light levels, which are to be saved as scenes, can either be set and saved at the panel or using the remote function allowing

for individual variations to be set by the users of each area without affecting the system configuration.

All of the DALI area systems were able to operate autonomously prior to the commissioning and system integration into the LONWORKS® backbone BMS, which was carried out with full transparency to the occupants.

Key benefits

- Optimised lighting control with interactive operation by BMS.
- No unnecessary communications traffic in the BMS backbone. Only specifically needed data can be targeted for transfer from the lighting control.
- Low total cost resulting from
 - low cost components
 - low cost for the installation
 - Easy configuration and commissioning – e.g. no dip switches to set.
 - Reduced recurring cost through individual component feedback.
 - occupancy and light measurement for an intelligent control of lighting and HVAC
 - status feedback, e.g. for lamp maintenance
 - information available for extra security
- Adaptable. A few simple changes in the configuration allow for an adaptation to changes in an area that is in use without any need for rewiring or exchanging of the components.
- Enhanced operating security. Each area can operated independently in the event of failures, be it another area or the BMS itself.

Appendix E 2

BASIC for simple applications

Inexpensive light control system using DALI components

Spotlight on simplicity

As the name suggests, the BASIC light control system has been designed for inexpensive, easy-to-install basic applications using the DALI interface protocol (Digital Addressable Lighting Interface). However, even BASIC offers enough convenience to create impressive lighting atmospheres. Its characteristics, such as easy operation, installation and commissioning, provide for great user-friendliness. There is no need for the programming of a device or a complicated training with a system that is confined to the essentials for the envisaged light applications.

Emphasis on flexibility

The BASIC light control system is suitable for numerous applications. The spectrum covers task-specific lighting situations in multi-purpose halls, just as much as in representative offices or conference rooms.

This system allows a free programming of up to four light schemes, one of which is reserved for constant-light control. In order to set these schemes, four groups are to be defined at the time of initialisation, although they may be changed at any time. The system permits the control of a maximum of 64 DALI subscribers.

The perfect lighting solution for numerous applications can be created in this simple way.

Good light for different activities

In the multi-purpose hall (*Fig. E 2.1*), which can be used either as a gym or as a hall for special events, the four luminaire groups have been installed as follows:

- Groups 1 to 3 are arranged in parallel to the window in order to create ideal conditions for daylight control.

- Group 4 was wired separately for the purpose of highlighting the stage on special occasions.

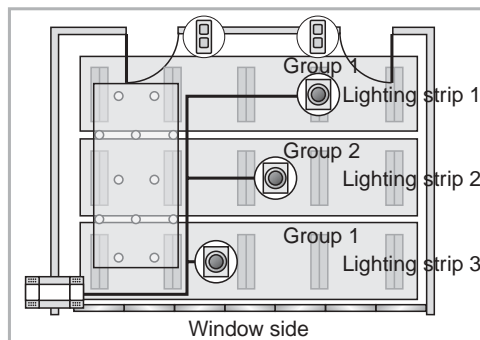

Figure E 2.1:
The multi-purpose hall presents itself for all occasions in the right “light outfit“

Under these circumstances, the following schemes could be programmed, for example:

- Scheme 1: Constant-light control (use of daylight) for sports activities
- Scheme 2: Evening sports activities
- Scheme 3: Stage light for concerts
- Scheme 4: Light for cleaning

This selection of schemes would provide for a good coverage of all (lighting) requirements for various types of events.

The right light for every working situation

Reading, making telephone calls, sitting at a computer and holding meetings are the main activities in an office of a departmental manager that the lighting has to be adapted to. Halogen luminaires and halogen downlights have been installed for this purpose in addition to pendant long-bay luminaires with fluorescent lamps (*Fig. E 2.2*). Luminaire groups have been defined as addresses for the lighting control:

The long-bay luminaires, which have been arranged in parallel to the window side (Groups 1 and 2), provide the basic illumination of the office forming the basis for a constant-light control. Group 3 consists of the halogen luminaire

above the conference table, which can also be daylight-controlled on request. Group 4 comprises the halogen downlights for highlighting purposes.

Figure E 2.2:
BASIC provides ideal lighting conditions for different activities in the representative office

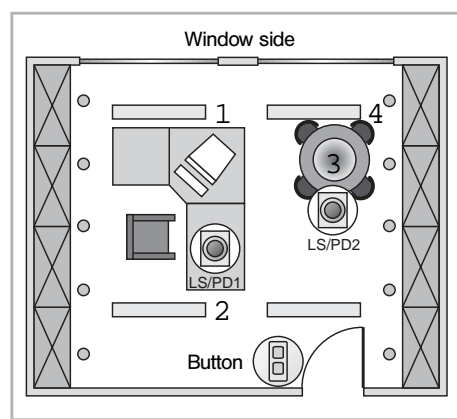

The following programming, for example, would provide the right, task-specific lighting atmosphere:

- Scheme 1: Basic lighting (daylight control, Groups 1 to 3)
- Scheme 2: Illumination of the conference table
- Scheme 3: Working light for computer work
- Scheme 4: Highlighting

This selection guarantees a suitable lighting atmosphere that the employee feels comfortable in.

Light makes for a pleasant atmosphere

The demands on the lighting in a conference room (*Fig. E 2.3*) are just as high as those for an office with high-quality furnishings. Therefore, a careful selection of the luminaires, lamps and their control is crucial for any application of this kind. In this instance the groups could be distributed as follows:

Group 1 provides the illumination of the conference table with halogen downlights. Downlights with circular fluorescent lamps are available for the basic lighting (Group 2).

Group 3 is responsible for brightening up the ceiling with wall-mounted uplights. Group 4 adds highlights to the basic lighting with halogen downlights.

The following lighting situations could be set by combining the groups individually:

- Scheme 1: Reception lighting
- Scheme 2: Conference lighting
- Scheme 3: Presentation lighting
- Scheme 4: Exhibition lighting for company presentations

This covers the range of lighting schemes perfectly, which may be required in the conference room.

Simple, but nevertheless intelligent

The possibility of arranging the individual groups, as specified at the time of commissioning, makes a good environment for the design of light schemes that use the BASIC system. A total of just five buttons guarantees a simple setting of the lighting situation (light scheme) via brightness values, which have been selected individually for the four groups. Similarly, it is no problem at all to change and store such schemes. The central function (On/Off/centralised dimming) has been assigned to the "big" button.

In view of the envisaged field of application, the confinement to four schemes is perfectly adequate. In this context, the wiring of the sensors on the controller assigns the constant-light control function to Groups 1 to 3. This is an expression of the consistent pursuit of the philosophy of simplicity in the BASIC system.

With the 'presence' function always linked to Scheme 1, a person entering the room will automatically trigger the activation of the constant-light scheme. The timer is restarted automatically, as long as a motion can be detected in the room. This situation is maintained in the event of a change in the light setting as well, until the sensor will give the command for automatic shut down. This will be "announced" in advance by a reduction of the brightness level to the minimum luminous flux.

Only after the set running time has expired (no motion in the room) does the system return to its basic state. The lighting can also be switched off manually, of course.

Figure E 2.3: BASIC makes it easy to create the typical lighting situations in a conference room

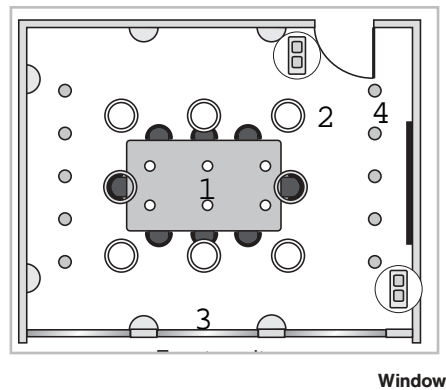

Should there be no requirement for the 'presence' or 'constant-light' function, the corresponding sensor connections will simply be out of use.

From simple to complex

All these characteristics make BASIC the ideal light control system to design light schemes for simple applications. More elaborate requirements are met by the ADVANCED light control system, which offers more convenience and will be presented in the next issue of ECG SPOT. Naturally, you will also be able to find the latest information on these light control systems on the web pages.

Appendix E 3

Example of a DALI application: combined work and training room

Description of the problem

A newly erected workroom in a workshop for the disabled is to be fitted with 8 work benches and a work desk for the instructor. Each row of work benches is to have a control for switching and dimming the row of lights above that work bench. This room is also to be used as a training room for technical instruction. The lighting for the whole work room consists of the following:

- 8 rows of 5 (1 x 58 W) Luminaires per row of work benches
- 1 row of 3 (1 x 58 W) Luminaires for the instructor's work desk and [black]board lighting

To ensure that the lights can be controlled on demand, high individual light management requirements. Nevertheless setting of the lights must not be too complicated and those working in the room must be able to do this without any special knowledge!

Because the room is sometimes used as a training room, yet another light control profile is required. The training instructor should be able to dim all of the lighting from his station. If no full room lightings is possible, the training instructor should also be able to switch and dim the lighting in double and single rows.

Solution

As the installation requires a high degree of flexibility in group control and must be simple to operate, DALI was the obvious solution. The specific DALI addresses can be seen in the table listed below and clearly match the demands expressed by the user.

DALI groups

Lighting	DALI Group No. (max. 16)	Can be operated from
1 st row of lights, work bench	1	Work bench 1, desk
2 nd row of lights, work bench	2	Work bench 2, desk
3 rd row of lights, work bench	3	Work bench 3, desk
4 th row of lights, work bench	4	Work bench 4, desk
5 th row of lights, work bench	5	Work bench 5, desk
6 th row of lights, work bench	6	Work bench 6, desk
7 th row of lights, work bench	7	Work bench 7, desk
8 th row of lights, work bench	8	Work bench 8, desk
Desk and blackboard lighting	9	Desk
All lights	10	Door, Desk
1 st + 2nd row of lights	11	Desk
3 rd + 4th row of lights	12	Desk
5 th + 6th row of lights	13	Desk
7 th + 8th row of lights	14	Desk

The DALI line has 14 DALI groups!

DALI Scenes

No scenes are required in this application

DALI components required

DALI operating elements (dimmable ballasts max. 64 per DALI line)

- 8 rows x 5 Luminaires and 1 row x 3 Luminaires (ballast 1x58 W)/light = 43 DALI ballasts

DALI power supply

- 1 DALI power supply

DALI group controller
– DALI group control unit for at least 13 DALI groups

Installation

DALI wiring
– Standard low voltage wiring (e.g. 5x1.5mm²)
Control elements (switches, buttons, control panels, etc.)
– Standard or as selected by the client

Row 1
Row 2
Row 3
Row 4
Row 5
Row 6
Row 7
Row 8
Desk light

Conclusion

All of the lighting requirements can be met with the definition of 14 DALI groups. DALI also offers the option of fast and easy adjustment, if the light profile should fundamentally change. This application does not have any light scenes because the occupation of the room changes several times a day.

Figure E3.1:
Workshop lighting

Index

A

address 22, 24
advantage 11
allocation 27
application 16, 28, 29

B

ballast 10, 23 ff
broadcast 24
building management 13

C

cable length 19, 31
combination 17
combined installation 26
communication 9
complexity 13
component 20, 25
configuration 20, 27
connection 26
control 11
– bus 31
– device 31, 34
– devices 11
– input 19
– lead 19
converter 20

D

data coding 18
– transfer rate 17
default values 12
dimming 11
– range 19

dimming time 20
– transfer 20

E
emergency lighting 12
exchangeability 10

F
fading 12
5-wire cable 32
flexibility 10, 28
functional units 17

G
group 12, 24
– adress 35

I
identification 12
IEC 60929 10
individual address 35
information 23
installation 27, 28, 31
– material 21
interface 10, 17
– supply 21
– voltage 17
interference 11
IR-receiver 30
isolation conditions 21

L
lead length 19
lighting scenes 20, 35
light management 10

M

Manchester code 18
messages 11
Multi-Master 24

O

objective 9
operating device 34

P

planning 28
– process 25
power consumption 23
– supply 22
pure subsystem 16

R

radio link 35
regrouping 20
resistor 19
revertive signals 19
ring-shaped connection 21

S

safety distance 18
scene 12
security 17
SELV 21
sensor 30
series wiring 26
simplicity 10
Single Master 23
stand-alone system 13
– – – subsystem 15
star configuration 26
star-shaped structures 21
sub-circuit 30
subsystem 13
switch 30

switch panels 25, 30
system 22
– current 19, 22
– operation 22
– size 19
– solution 11

T
translator 16
tree-shaped structures 21
type of fittings 25

U
units 12, 23

V
variations 29
voltage drop 33
– ratings 18

W
www.dali-ag.org. 13